

FPD3-9000-11000-20-S

3-Way, 9~11GHz

Features:
 * Small Size
 * Low Insertion Loss

Applications:
 * Amplifiers
 * Mixers
 * Antennas
 * Laboratory Test

Electrical

Frequency:	9~11GHz
Insertion Loss:	0.8dB max.
Input VSWR:	1.4 max.
Output VSWR:	1.3 max.
Isolation:	18dB min.
Amplitude Balance:	0.5dB max.
Phase Balance:	±5°
Impedance:	50Ω
Power @SUM Port:	20W max. as divider 1W max. as combiner

Mechanical

Size ^{*1} :	38*51*10mm 1.496*2.008*0.394in
Weight:	52g
Connectors:	SMA Female
Mounting:	4-Φ3.2mm through-hole

[1] Exclude connectors.

Environmental

Operation Temperature:	-45~+85°C
------------------------	-----------

Outline Drawings

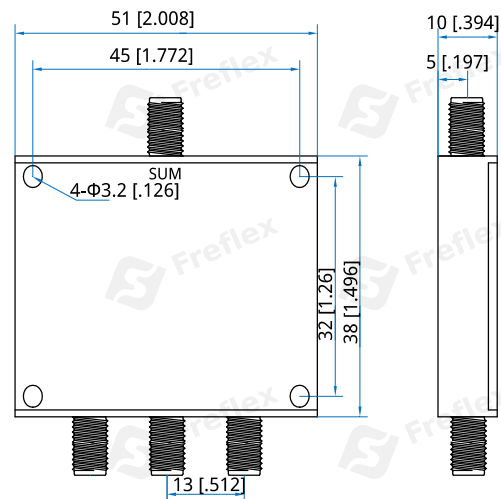

Unit: mm [in]
 Tolerance: ±0.5mm [±0.02in]

How To Order
[FPD3-9000-11000-20-S](#)

Customization is available upon request.