

FBM-10-2000

10~2000MHz

Features:

- * Low Conversion Loss
- * High Isolation

Applications:

- * Wireless
- * Transceiver
- * Laboratory Test
- * Broadcast

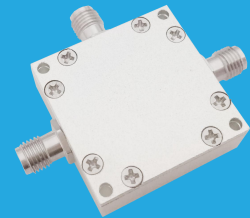
Electrical

LO/RF Frequency:	10~2000MHz
LO Input Power:	7dBm typ.
IF Frequency:	10~1000MHz
Conversion Loss:	10dB typ.
LO & RF Isolation:	30dB typ.
LO & IF Isolation:	40dB typ.
IF & RF Isolation:	20dB typ.

Absolute Maximum Ratings

RF Input Power:	+17dBm
-----------------	--------

Mechanical

Size*1:	30*30*10mm 1.181*1.181*0.394in
---------	-----------------------------------

Connectors: SMA Female

[1] Exclude connectors.

Environmental

Operating Temperature:	-20~+70°C
Non-operating Temperature:	-40~+85°C

Typical Performance Curves

LO VSWR vs. Frequency
Test Power:7dBm

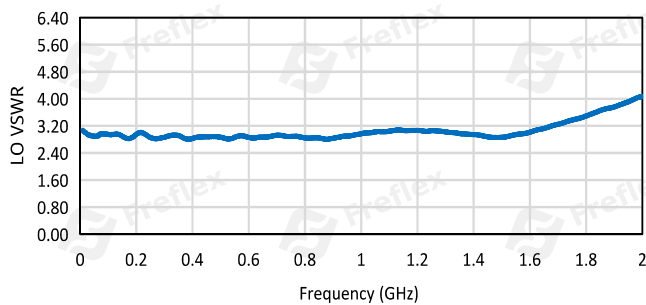

RF VSWR vs. Frequency

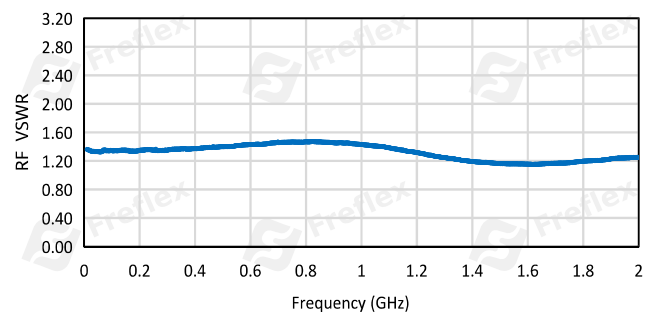
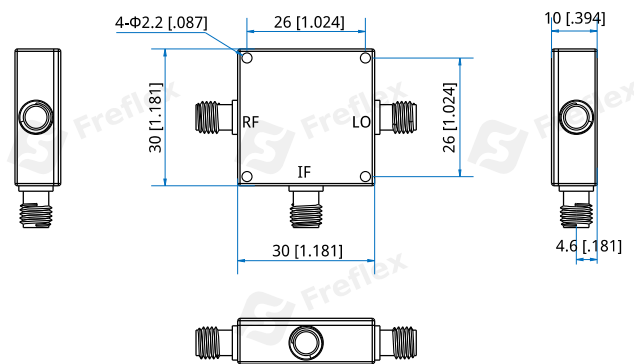
Outline Drawings

Unit: mm [in]

Tolerance: ±0.2mm [±0.008in]

How To Order

FBM-10-2000

Customization is available upon request.

Balanced Mixers

IF VSWR vs. Frequency

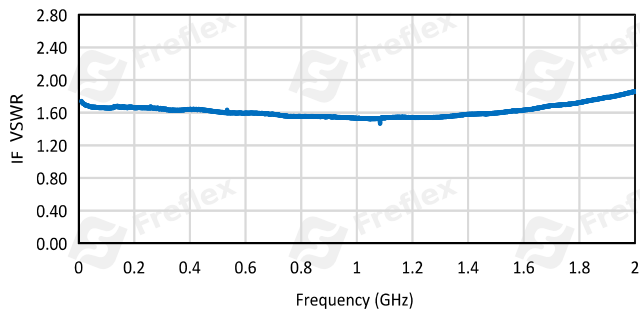

LO-IF Isolation vs. Frequency

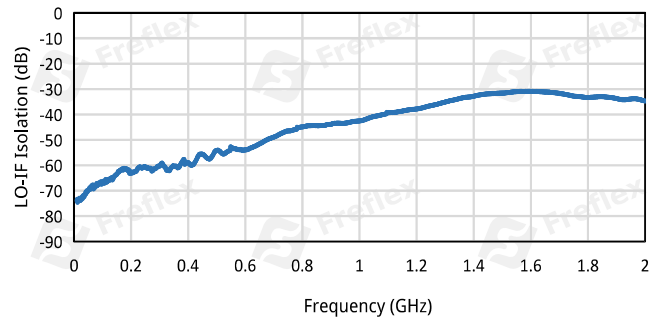

LO-RF Isolation vs. Frequency

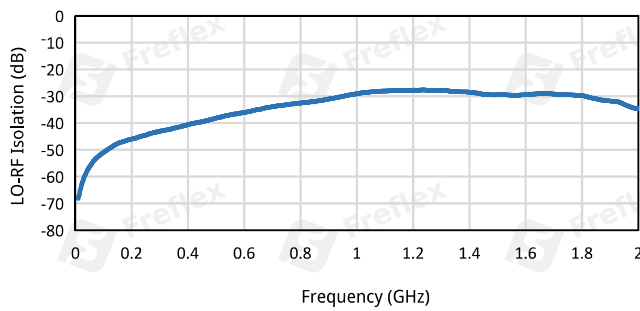

IF-RF Isolation vs. Frequency

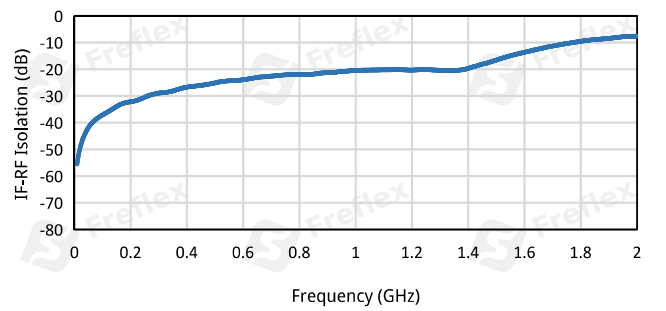

Conversion loss vs. Frequency

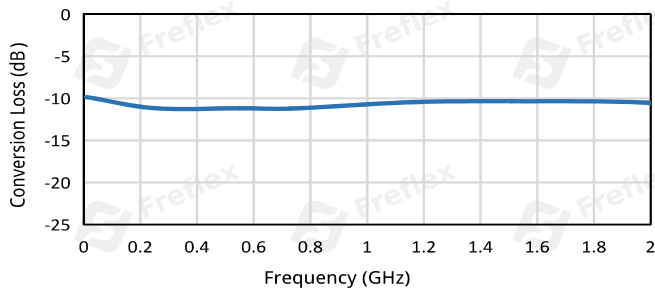

LO Power: 7dBm IF Frequency: 30MHz