

FDA-6000-26500-31.5-0.5

6~26.5GHz, 31.5dB, 0.5dB

Features:
 * Broadband
 * High Dynamic Range

Applications:
 * Wireless
 * Transmitter
 * Laboratory Test
 * Radar

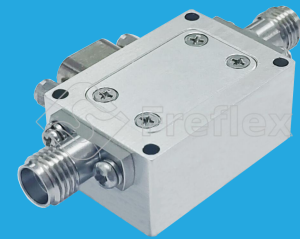

Electrical

Frequency:	6~26.5GHz
Insertion Loss:	6dB typ.
Step:	0.5dB
Attenuation Range:	0~31.5dB
Attenuation Accuracy:	±0.7dB typ. @0.5~16dB ±2.5dB typ. @16~31.5dB
VSWR:	2 typ.
Voltage/Current:	-5V @15mA typ.

Absolute Maximum Ratings*1

Voltage:	-6V max.
Input Power:	+27dBm max.

[1] Permanent damage may occur if any of these limits are exceeded.

Mechanical

Size*2:	26*18*12mm 1.024*0.709*0.472in
RF Connectors:	SMA Female
Switching Time:	50ns max.
Power Supply & Control	J30J-9ZKP
Interface Connectors:	
Mounting:	4-Φ1.8mm through-hole
Logic Input:	On: 1(+3~+5V) Off: 0(0~+0.5V)

[2] Exclude connectors.

Pin Numbering

Pin	Function	Pin	Function
1	C1:-0.5dB	6	C6:-16dB
2	C2:-1dB	7	VEE
3	C3:-2dB	8	NC
4	C4:-4dB	9	GND
5	C5:-8dB		

Environmental

Operating Temperature:	-45~+85°C
Non-operating Temperature:	-55~+125°C

Outline Drawings

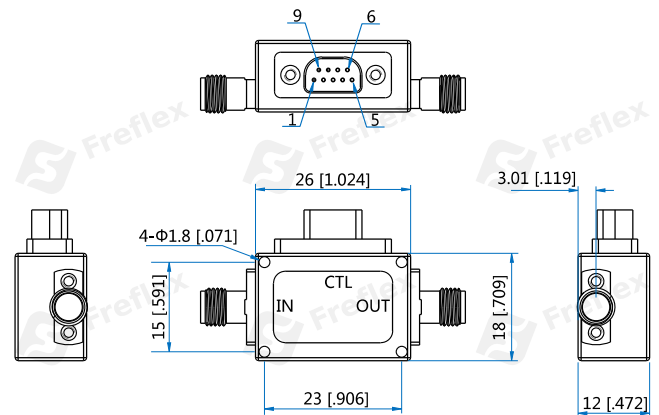

Unit: mm [in]

Tolerance: ±0.2mm [±0.008in]

Logic Table

State	C1	C2	C3	C4	C5	C6	VEE	Attenuation State
-	0	0	0	0	0	0	-5V	Reference IL
1	1	0	0	0	0	0	-5V	0.5dB
2	0	1	0	0	0	0	-5V	1dB
3	0	0	1	0	0	0	-5V	2dB
4	0	0	0	1	0	0	-5V	4dB
5	0	0	0	0	1	0	-5V	8dB
6	0	0	0	0	0	1	-5V	16dB
7	1	1	1	1	1	1	-5V	31.5dB

How To Order

FDA-6000-26500-31.5-0.5

Customization is available upon request.

Typical Performance Curves

