

FLAS-2000-18000-18-30

2~18GHz, 18dB, 3dB

Features:
 * Broad Band
 * Low Noise

Applications:
 * Wireless
 * Receiver
 * Laboratory Test
 * Radar

Electrical

Frequency:	2~18GHz
Gain:	18dB min.
Gain Flatness:	±1.5dB typ.
Output Power (P1dB):	10dBm min.
Noise Figure:	3dB typ.
Spurious:	-60dBc max.
VSWR:	1.5 typ.
Voltage:	+220V AC
Impedance:	50Ω

Mechanical

Size*1: 136*186*52mm
 5.354*7.323*2.047in

RF Connectors: SMA Female

[1] Exclude connectors, rack mount brackets, handles.

How To Order

FLAS-2000-18000-18-30

Customization is available upon request.

Environmental

Operating Temperature:	-20~+50°C
Non-operating Temperature:	-40~+85°C

Outline Drawings

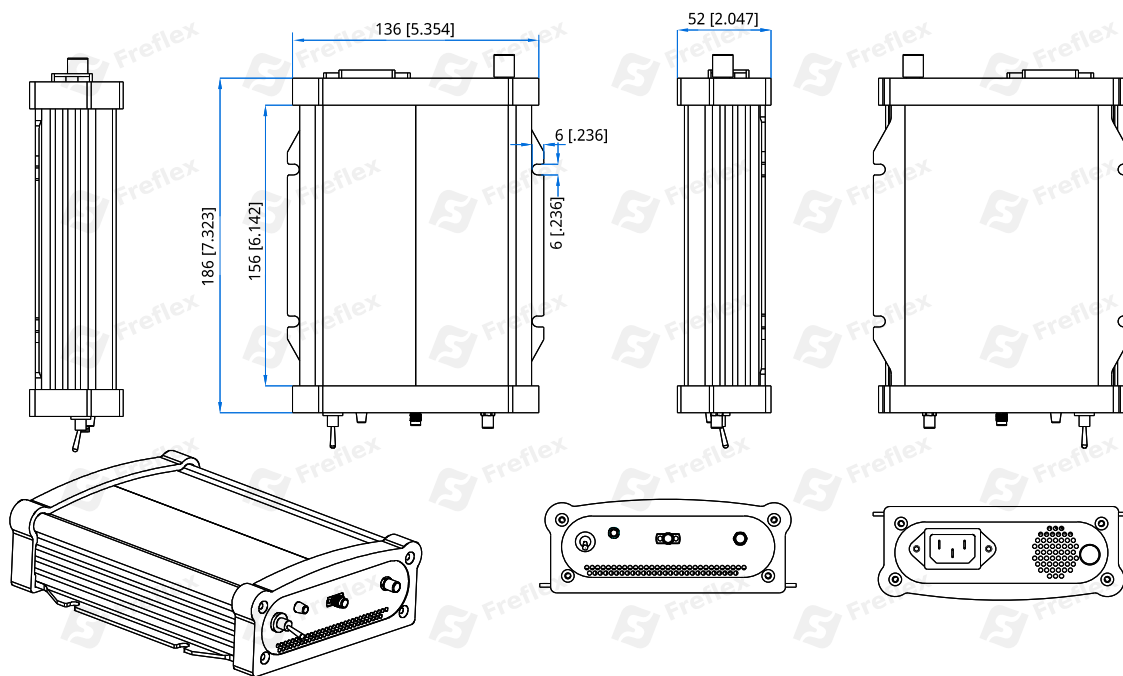

Unit: mm [in]
 Tolerance: ±0.2mm [±0.008in]