

FLAS-8000-18000-38-15

8~18GHz, 38dB, 1.5dB

Features:
 * Broadband
 * Low Noise

Applications:
 * Wireless
 * Receiver
 * Laboratory Test
 * Radar



Electrical

Frequency:	8~18GHz
Gain:	38dB typ.
Gain Flatness:	±1.5dB typ.
Output Power (P1dB):	18dBm typ.
Noise Figure:	1.5dB typ.
Spurious:	-60dBc max.
VSWR:	1.6 typ.
Voltage:	+85~+265V AC
Current:	200mA typ.
Impedance:	50Ω

Absolute Maximum Ratings*1

RF Input Power: +20dBm

[1] Permanent damage may occur if any of these limits are exceeded.

Mechanical

Size*2: 136*186*52mm
 5.354*7.323*2.047in

RF Connectors: SMA Female

[2] Exclude connectors, rack mount brackets, handles.

Environmental

Operating Temperature: -20~+50°C

Non-operating Temperature: -40~+85°C

How To Order

[FLAS-8000-18000-38-15](#)

Customization is available upon request.

Outline Drawings

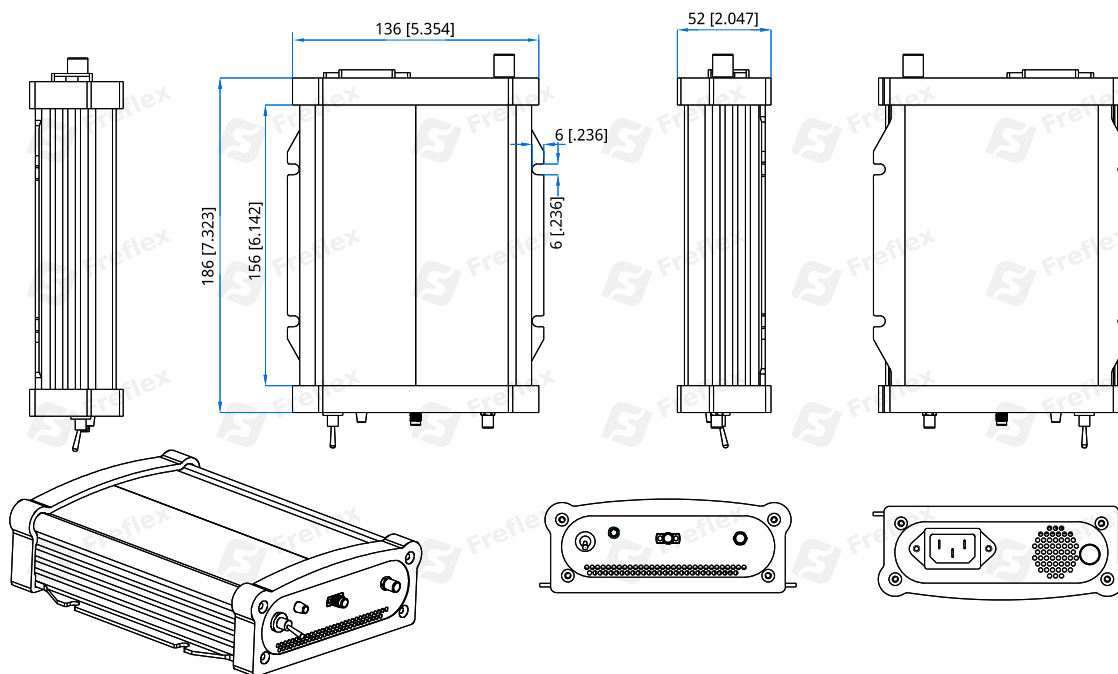

Unit: mm [in]

Tolerance: ±0.5mm [±0.02in]