

## FLA-100-18000-25-40

0.1~18GHz, 25dB, 4dB

Features:  
 \* Broad Band  
 \* Low Noise

Applications:  
 \* Wireless  
 \* Receiver  
 \* Laboratory Test  
 \* Radar

### Electrical

Frequency:	0.1~18GHz
Small Signal Gain:	25dB min.
Gain Flatness:	±2.5dB max.
Output Power (P1dB):	+17dBm min.
Noise Figure:	4dB max.
VSWR:	2 max.
Voltage:	+12V DC
Current:	270mA max.
Impedance:	50Ω

### Mechanical

Size <sup>*1</sup> :	40*35*12mm 1.575*1.378*0.472in
RF Connectors:	SMA Female
Mounting:	4-Φ2.2mm through-hole

[1] Exclude connectors.

### Environmental

Operating Temperature:	-40~+70°C
Non-operating Temperature:	-55~+100°C

### Outline Drawings

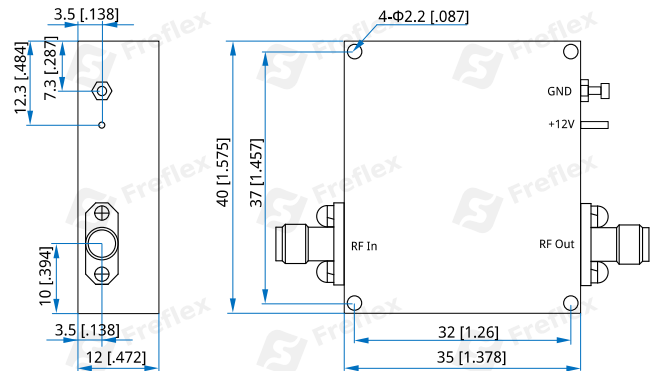

Unit: mm [in]  
 Tolerance: ±0.2mm [±0.008in]

### How To Order

**FLA-100-18000-25-40**

Customization is available upon request.