

# FLF-7000-50

## DC~7GHz, 50dB

**Features:**

- \* High Stopband Rejection
- \* Small Size

**Applications:**

- \* Telecom
- \* Laboratory Test
- \* Receivers
- \* Instrumentation

**Electrical**

Frequency:	DC~7GHz
Insertion Loss:	1dB max. @DC~6.9GHz 1.5dB max. @6.9~7GHz
VSWR:	1.3 max.
Stop Band Attenuation:	50dB@7.77~15.5GHz min.
Average Power:	15W max.
Impedance:	50Ω

**Mechanical**

Size <sup>*1</sup> :	31*23*10mm 1.22*0.906*0.394in
RF Connectors:	SMA Female
Mounting:	4-Φ2.2mm through-hole

[1] Exclude connectors

**Environmental**

Operating Temperature:	-55~+85°C
------------------------	-----------

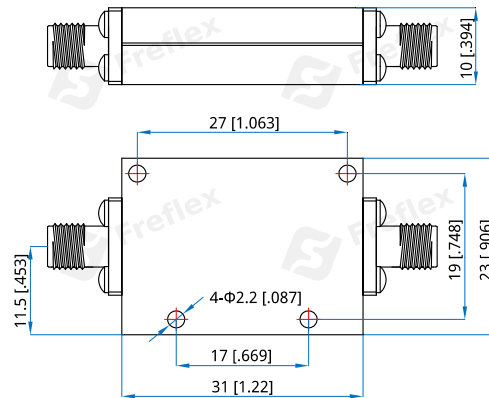
**Outline Drawings**

Unit: mm [in]

Tolerance: ±0.2mm [±0.008in]

**How To Order**

**FLF-7000-50**

Customization is available upon request.