

FLF-8000-50

DC~8GHz, 50dB

Features:

- * High Stopband Rejection
- * Small Size

Applications:

- * Telecom
- * Laboratory Test
- * Receivers
- * Instrumentation

Electrical

Frequency:	DC~8GHz
Insertion Loss:	1dB max. @DC~7.9GHz 1.5dB max. @7.9~8GHz
VSWR:	1.4 max.
Stop Band Attenuation:	50dB@8.8~16.2GHz min.
Average Power:	15W max.
Impedance:	50Ω

Mechanical

Size ^{*1} :	30*22*10mm 1.181*0.866*0.394in
RF Connectors:	SMA Female
Mounting:	4-Φ2.2mm through-hole

[1] Exclude connectors

Environmental

Operating Temperature:	-55~+85°C
------------------------	-----------

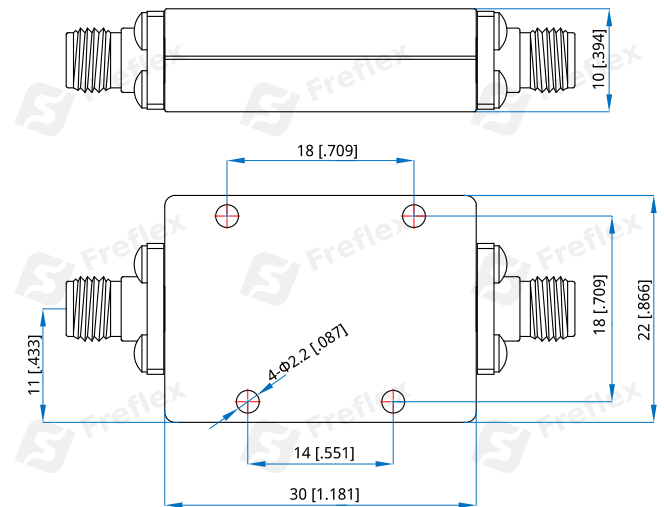
Outline Drawings

Unit: mm [in]

Tolerance: ±0.2mm [±0.008in]

How To Order

FLF-8000-50

Customization is available upon request.