

## FPDO-E-10-7

### External Reference, 10MHz, 7GHz

**Features:**

- \* High Frequency Stability
- \* Ultra Low Phase Noise

**Applications:**

- \* Wireless
- \* Transceiver
- \* Laboratory Test
- \* Radar

#### Electrical

Output Frequency:	7GHz
Output Power:	13dBm min.
External Reference:	10MHz
Reference Input Power:	0±3dBm
Output Phase Noise:	≤-70dBc/Hz@100Hz ≤-95dBc/Hz@1KHz ≤-115dBc/Hz@10KHz ≤-120dBc/Hz@100KH ≤-120dBc/Hz@1MHz
Output Spurious:	-70dBc max.
Output Harmonic:	-20dBc max.
Voltage:	+12V DC
Current:	550mA max. (stable) 700mA max. (first)
Lock Indicator (LI):	TTL logic High: locked Low: unlocked

#### Mechanical

Size*1:	57.2*57.2*33.8mm 2.252*2.252*1.331in
RF Connectors:	SMA Female
Power Supply Interface:	Feed Through/Terminal Post
Mounting:	4-M2.5mm through-hole

#### Environmental

Operating Temperature:	-40~+75°C
Non-operating Temperature:	-55~+85°C

#### Outline Drawings

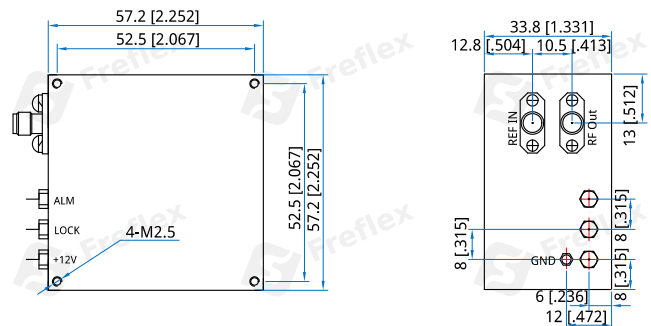

Unit: mm [in]  
Tolerance: ±0.2mm [±0.008in]

#### How To Order

##### FPDO-E-10-7

Customization is available upon request.