

FPVO-E-10-12.8

External Reference, 10MHz, 12.8GHz,

Features:

- * High Frequency Stability
- * Low Phase Noise

Applications:

- * Wireless
- * Transceiver
- * Laboratory Test
- * Radar

Electrical

Output Frequency:	12.8GHz
External Reference:	10MHz
	-170dBc/Hz@10KHz
Input Power:	0±2dBm
Output Power:	13dBm min.
Phase Noise:	-80dBc/Hz@10KHz
Harmonic:	-20dBc max.
Spurious:	-70dBc max.
Voltage:	+12V DC
Current:	700mA max.
Lock Indicator (LI):	TTL logic
	High: locked
	Low: unlocked

Mechanical

Size*1:	74*50*16mm
	2.913*1.969*0.63in
RF Connectors:	SMA Female
Power Supply & Control Interface:	Feed Through/Terminal Post
Mounting:	4-M2.5 through hole

[1] Exclude connectors.

Environmental

Operating Temperature:	-40~+75°C
Non-operating Temperature:	-55~+85°C

Outline Drawings

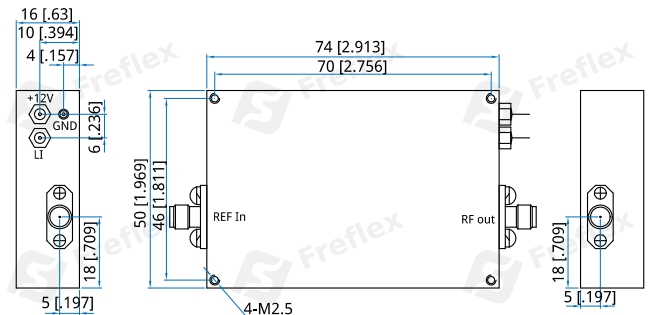

Unit: mm [in]

Tolerance: ±0.2mm [±0.008in]

How To Order

FPVO-E-10-12.8

Customization is available upon request.