

FPS3-500-40000-A

SP3T, 0.5~40GHz, Absorptive

Features:

- * Low Insertion Loss
- * High Isolation

Applications:

- * Wireless
- * Transmitter
- * Laboratory Test
- * Radar

Electrical

Frequency:	0.5~40GHz
Insertion Loss:	5dB max.
Isolation:	60dB min.
VSWR:	2.8 max.
Input Power:	23dBm max.
Voltage/Current:	+5V@120mA max. -5V@50mA max.
Control:	TTL High - 1 TTL Low/NC - 0
Impedance:	50Ω

Mechanical

Size ^{*1} :	24*20*12mm 0.945*0.787*0.472in
Switching Time:	50nS max.
RF Connectors:	2.92mm Female
Power Supply Connectors:	Feed Through/Terminal Post
Housing Material:	Gold plated aluminum or Nickel plated aluminum
Mounting:	4-Φ2.2mm through-hole

[1] Exclude connectors.

Environmental

Operating Temperature:	-45~+85°C
Non-operating Temperature:	-55~+125°C

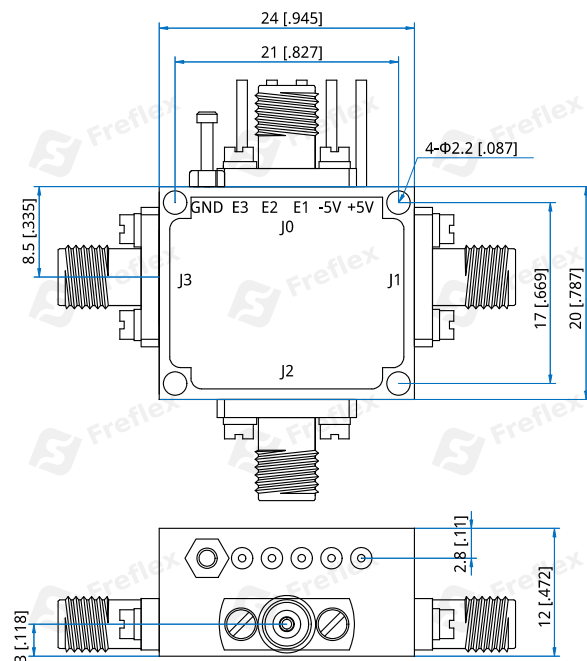
Outline Drawings

Unit: mm [in]

Tolerance: ±0.2mm [±0.008in]

Control True Table

E1	E2	E3	Connection
0	1	1	J0 - J1 On
1	0	1	J0 - J2 On
1	1	0	J0 - J3 On

How To Order

FPS3-500-40000-A

Customization is available upon request.